



2023 206 Canada Rule Set



Effective January 16, 2023
(Last updated February 15, 2022)

The 206 engine platform was designed and engineered exclusively for racing. Each engine is hand-built in Milwaukee, Wisconsin using dedicated tooling and dies to provide a level of consistency unmatched in the industry today.

The 206 is intended to simplify racing, from hitting the track to the tech process needed to ensure a level playing field at the end of the day. In combination with Briggs & Stratton Racing's slide restriction system a complete racing ladder can be developed by simply changing a carburetor slide and/or by a slide and ignition change. With the base engine the basis for today's 'box stock' classifications, the 206 engine gives racers and tracks the ability to have one engine, from start to finish.

All Briggs & Stratton (B&S) racing engines are manufactured solely for sanctioned racing only. B&S does not recommend the products referenced herein to be used for any application outside of sanctioned racing as serious injury or death could result.

This rule package has been prepared by Briggs & Stratton Racing and is intended to establish the sole basis for technical control of the 206 engine in competition. For all supplemental rules contact your sanctioning body.

**UNLESS THESE RULES STATE THAT YOU
CAN DO IT, YOU CANNOT DO IT.**

**EACH RACER IS SOLELY RESPONSIBLE TO MAINTAIN AND
CHECK ENGINE LEGALITY PER THIS PUBLISHED RULE SET**

**This rule package covers all engine related technical specifications.
For all other regulations beyond the engine please refer or contact your
sanctioning body.**

CONTENTS

1.	Briggs & Stratton Racing Class Structure.....	3-4
2.	These Regulations Are the Only Regulations	4
2.5.	The 3 Core Rule Set Technical Inspection Principles	4
3.	Briggs & Stratton 206 Product Availability	4
4.	General Rules	5
5.	Things That Are NOT Permitted.....	5-6
6.	Factory Security Seals.....	6
7.	Technical Inspection Tools	6
8.	Engine Ignition Switch.....	6
9.	Engine Air Filter	6-7
10.	Engine Fuel Recommendations	7
11.	Engine Oil	7
12.	Oil Breather.....	7
13.	Oil Catch Container.....	7
14.	Carburetor Overflow	7
15.	Fuel Pump.....	8
16.	Cooling Shrouds, Covers and Blower Housings	8
17.	Damaged Thread Repair	8
18.	Carburetor & Intake Manifold	9-11
19.	Cylinder Head	12
20.	Head Gasket.....	12
21.	Ports	13
22.	Valves	13
23.	Valve Springs	14
24.	Rocker Arms, Rocker Ball and Rocker Arm Studs	14
25.	Push Rods	14
26.	Engine Block.....	15
27.	Valve Lift, Rocker Cover Fasteners	15
28.	Camshaft Profile Limits.....	16
29.	Flywheel	16
30.	Ignition System, Spark Plug and Ignition Timing	16-17
31.	Crankcase	17
32.	Clutch	17-18
33.	Starter	18
34.	Exhaust Header.....	18-19
35.	Exhaust Silencer	19
36.	Exhaust Protection.....	19
37.	Technical Inspection Tools	19
38.	Important Online Support Resources	19
39.	TOOL REFERENCE.....	20
40.	APPROVED CLUTCH GUIDE	21-25
41.	TORQUE SETTING GUIDELINES	25

1. Canadian Eligibility

The Briggs & Stratton LO206 Canadian Engine is built for the Canadian market and has a unique specification. The only LO206 engines that are eligible for Canadian competition by Canadian residents are identified with a special embossed stamp on the base of the engine block. Engines that do not bear the official special embossed stamp cannot be used by Canadian residents.



1.5 Canadian Racing Class Structure

The following class structure chart is effective for 2021. Clubs and organizations can alter the class structures and weights to suit their driver licensing protocols. Reference Rule #29 regarding ignition modules.

Canadian Racing "National Class" Structure			
Class	Weight Lbs.	Engine Package	Technical Configuration
National Cadet (formerly Novice)	235	LO206 w/carb lock	RLV pipe Part #EXF5507 Briggs Red Slide .440" opening Briggs Part #555733
Junior	300	LO206 w/carb lock	RLV pipe Part #EXF5507 Briggs Yellow Slide .570" opening Briggs Part #555741
Junior Light	265	LO206 w/carb lock	RLV pipe Part #EXF5507 Briggs Blue Slide .520" opening Briggs Part #555734
Senior	340	LO206	RLV pipe Part #EXF5507 Briggs Stock slide Part #555590
Masters	375	LO206	RLV pipe Part #EXF5507 Briggs Stock Slide Part #555590
Canadian Racing "Club Class" Structure			
Class	Engine Package	Technical Configuration	
"Club Cadet"	LO206 w/carb lock	RLV pipe Part #EXF5507 Briggs Black Slide .310" opening. Part #555732 Briggs Ignition Part 555725 Black (4150 RPM +/-50)	
"Club Junior Light"	LO206 w/carb lock	RLV pipe Part #EXF5507 Briggs Blue Slide .520" opening Briggs Part #555740	

National Cadet & Junior & Club Cadet and Junior Light, requires the installation of the locking cap Part #555726 on the carburetor slide cover. It is not permitted to run the classes without the specified slide and locking cap. The locking cap and carb cap MUST be tight. Opening is to be verified by pulling on the throttle cable, not the pedal, to determine maximum opening.



Optimization of the slide opening in Briggs & Stratton National Cadet, Junior, Junior Light and Club classes is permitted. The only allowable method of slide optimization is by removing material from the throttle cap area highlighted in RED. The use of multiple gaskets and/or machining of the slide is prohibited.



Slide opening must not exceed the appropriate No-Go specification as per class regulations. For information on slide optimization see video section at www.BriggsRacing.com

CAUTION – The risk of pushing the limit on the slide opening can lead to an unnecessary DQ. An additional .010” of slide opening has the potential to give only .1 hp. Give yourself a buffer to ensure success at tech inspection.

2. These Regulations Are the Only Regulations

- a. Only the B&S Racing Engine Division in Milwaukee can make changes to the technical specifications herein.
- b. B&S dealers and their agents are not authorized to alter, verbally or otherwise, any technical specifications or competition rule herein.
- c. Should any B&S literature, catalogues, manuals, videos, etc. be different than these regulations, these regulations take precedence.
- d. Changes, corrections, addendums, etc. will be submitted to sanctioning bodies and posted at www.karting.com for republication and will become effective on a date specified.
- e. Previous mid-season updates are to be considered void upon publication of an annual update.

2.5. The 3 Core Rule Set Technical Inspection Principles

- a. Unless these rules state that you can do it, you cannot do it.
- b. Spirit and Intent (Syd White rule): Covered, stated, restated, or unstated any change or action with the sole intent to wrongfully create a performance advantage is grounds for disqualification.
- c. All parts are subject to comparison with a known stock part. This includes specified and mandated aftermarket parts. Example: RLV exhaust and silencer.

3. Briggs & Stratton 206 Product Availability

The 206 engine products and service parts manufactured by Briggs & Stratton are available only through the authorized Briggs & Stratton Racing dealers.

A list of authorized dealers can be found at www.briggsracing.com/support

4. General Rules

- a. The terms stock, original equipment, OEM, unaltered, etc., refer to Original Equipment supplied by Briggs & Stratton or specified manufacturer.
- b. Only the original equipment Briggs & Stratton 206 #124332-8201-01 or Junior 206 #124332-8202-01 engines are allowed in the classes recommended herein.
- c. All parts must be unaltered Briggs & Stratton 206 parts specifically made for these engines by Briggs & Stratton. No aftermarket parts to be used unless specified in these regulations.
- d. All parts are subject to comparison with a known stock part. This includes specified and mandated aftermarket parts. Example: RLV exhaust and silencer.
- e. A tech official may use additional means of measuring components to compare against a known stock part.
- f. The tech official, at their sole discretion, may at any time replace a competitor's sealed engine, carburetor, or head assembly with another sealed engine or known stock part. Failure to comply is grounds for disqualification.
- g. If a competitor's part is replaced per 4f it must be drilled or reconfigured in a way that prohibits the reuse of that part.
- h. All Briggs & Stratton 206 classes must have a serialized block. Blocks without a factory serialization on the front base next to the oil drain are illegal in competition.
- i. Standard organizational protest procedures can allow for short block inspection (seal removal) if a new, replacement short block, p/n 555715 is offered in replacement. Competitor short block to be forfeited to the series or club as terms of this procedure.

5. Things That Are NOT Permitted

- a. Tampering with either of the two factory-installed engine seals.
- b. Addition or subtraction of material in any form or matter.
 - Exception – Valve maintenance (valve job). Valve seats must remain with the factory specification of 30 and 45 degree angles only. Valve seats of additional angles and/or angles not comparable to the factory stock of 30 and 45 degrees are not permitted. Grinding of valve stem or excessive material removal prohibited.
 - Exception – Optimization of the slide opening in Briggs & Stratton Cadet, Novice, Junior 1, Junior 2 and ASN National Junior classes are permitted per Section 1 guidelines.
- "Blueprinting" unless stated herein.
- Modification to or the machining of any parts in order to bring them to stated minimum/maximum specification, (or for any reason).

- Machining or alteration of any kind to the engine or replacement parts unless specifically stated herein.
- Deburring, machining, honing, grinding, polishing, sanding, media blasting, etc.
- Sandblasting or glass-beading any interior engine surfaces.
- No device may be used that will impede, or appear to impede, airflow to the engine cooling system including the recoil starter or blower housing.

6. Factory Security Seals

There are two custom security seals with matching serialization installed from the factory. Tampering of the seals is not permitted. Should the seals be tampered with, the engine is no longer eligible for competition. If an engine require dismantling for any reason that requires breaking of the seals, contact Briggs & Stratton at: briggsracing@basco.com



The reflective hologram aluminum seal features a black tracer wire and a silver or black anodized body as shown



The orange housing seal features a red and black tracer wire, etched 'B&S Racing' type, and matching seal serial numbers

The only security seals that are legal have either a single black tracer wire with a reflective hologram seal or a red/black tracer wire with an orange housing seal. Plain cable seals are not approved for competition.

Each competitor is responsible for the condition of their seal. We recommend that each seal be wrapped (plastic bag, etc.) to prevent exposure from harsh chemicals.

7. Technical Inspection Tools

Briggs & Stratton have made available a number of tools for the convenience of technical checking of components when necessary. They are indicated throughout the rule set this way: "**Tech Tool #**" See Section 38 for tool description. The tools are available from Sox Racing (803) 791-7050.

8. Engine Ignition Switch

The B&S ignition switch and wires must remain in stock location. It is not permitted to alter the OEM wiring.

9. Engine Air Filter

The only air filter permitted is the Briggs & Stratton Green Air Filter Service Part #555729. No modification to the filter element is allowed.



A protective shield may be attached for wet-weather competition. It is not permitted for the protective shield to create any ram-air effect.

A fabric prefilter is allowed as long as it does not create a ram-air effect. Foam or any other prefilter material is NOT legal for use.

A racer MUST start each race with the air filter properly attached but will NOT be penalized if the air filter falls off during the race. If air filter falls off during a race, it is STILL subject to tech.

10. Engine Fuel Recommendations

Premium Gasoline no greater than 94 octane sold at normal roadside fuel stations open to the public. The addition of fuel additives in any manner is not permitted. Fuel dispensing location may be specified in Event Supplementary Regulations. Specific gravity and hydrometer testing are acceptable tests when used in accordance to sanctioning body guidelines.

11. Engine Oil

High-quality synthetic oil within a 10W-20 range recommended. No oil additives are permitted.

Briggs & Stratton only recommends the use of Briggs & Stratton 4T Synthetic Racing Oil. 4T was engineered exclusively for the rigors of high revving, air-cooled racing engines (available through both Briggs Racing and Amsoil dealers). The use of 'karting' or 'automotive' oils is not recommended as many are hydroscopic in nature (attract water), offer limited protection over time, and/or were engineered for pressure, not splash lube systems. The use of these oils can induce engine failure and/or accelerate wear.

Engine oil testing/verification procedure is per standard sanctioning body guidelines.

12. Oil Breather

Rocker cover oil breather must vent to a catch container.

13. Oil Catch Container

An oil overflow catch system is mandatory. Overflow tube must run from the rocker cover breather to a catch container. The container must be vented to the atmosphere.

13.5 Oil Drain and Fill

One magnetic drain plug may be used (recommended in the lower opening). Oil fill caps are non-tech but must be secure and air tight.

14. Carburetor Overflow

Carburetor overflow must be vented to a catch container. The container must be vented to the atmosphere.

15. Fuel Pump

Only fuel pump, B&S service part number 808656 or 597338, is legal for competition. This fuel pump can be identified by the Briggs & Stratton diamond logo and number 808492 or 027013 stamped on the pump face. All other pumps are prohibited. It is prohibited to pulse from the intake manifold.

Relocation of the fuel pump is legal as long as it is spaced to less than 3/4 inch off the control plate, B&S #555699, in a similar location that is both safe and secure. Measurement is from the base of the control plate to the bottom of the fuel pump. Vertical mounting or mounting the fuel pump upside down is illegal. The fuel pump must be pulsed from a pulse fitting mounted on the oil fill fitting located on the engine side cover. Aftermarket one-piece filler/pulse fittings are permitted. Check valves prohibited.

The use of silicone sealant on the brass vent IS permitted and recommended. A fuel pump return line to the fuel tank is prohibited.

The fuel line from pump to carburetor must be a single piece of flexible tubing secured at both ends. Inner diameter of the fuel line must be uniform and continuous with an ID of 1/4" (6mm) and completely free of any means to create an obstruction of fuel flow.

A fuel filter is not required but highly recommended to insure that dirt and contamination within your fuel system does not impact engine performance.

The fuel filter itself is not a tech item but only one fuel filter is legal for use and it can only be located between the fuel tank and fuel pump inlet (not between the pump outlet and carburetor).

16. Cooling Shrouds, Covers and Blower Housings

All pieces of the engine cooling shroud/blower housing and control panel must be stock B&S and properly installed. Rewind housing and cooling shroud (air guard) must remain stock as painted from the factory.

Engine Shroud may be painted any color. Any bolt, with the exception of the head bolt, that is used to secure sheet metal shrouds and covers may be replaced with larger diameter bolts.

No taping, covering, or restricting of air to the rewind shroud is permitted. Quick-release throttle cable linkages are allowed, provided they are securely mounted to control plate.

17. Damaged Thread Repair

It is permitted to use Heli-coil, Time-sert or a similar thread repair insert for shrouds, valve cover, oil drain, oil fill holes, blower housing, and exhaust pipe attachment studs on the head and lower brackets.

18. Carburetor & Intake Manifold

The B&S stock carburetor part #555658 is the only carburetor permitted. 'Walbro', 'Briggs' diamond logo and/or #590890 etched in the body are additional visual indicators. No alterations allowed unless stated below. All parts will be compared to a stock known B&S part for eligibility. This includes the nozzle, emulsion tube, jets, float, float needle and all other carburetor parts. It will be allowed however to adjust the float height by means of bending the small tab on the float arm.

A slight chamfer around the choke bore ID (air horn) may be present. 1.149" no go **Tech Tool A7**.

Both idle and main jet must remain stock, as shipped from the factory.



Slide to remain B&S stock unaltered. Slide cutaway to be measured on flat surface. .075 no go **Tech Tool A10**. All intake manifold fasteners to remain factory stock. The use of studs, etc. is illegal.

The fastener that attaches the carburetor to the intake manifold closest to the valve cover may be replaced by a longer drilled M6x1.0 bolt for wire engine sealing by a sanctioning body. Fastener must remain stock as approved by the sanctioning body

All individual carburetor components must be tight, and must remain UNALTERED as shipped from the factory.

B&S stock unaltered aluminum needle is required part number 555602 marked #BGB. Needle to be inspected using **Tech Tool A4**. Needle, when placed in tool A4, should not protrude through the other side. If needle protrudes through the block it is out of specification.

Throttle cable cap on the top of the carburetor must be properly installed and secured in the fully tight position.

Metal choke cover must remain in place but may be secured with silicone or epoxy sealer. Additional pin punching is allowed to tighten choke cover.

Air must only enter the engine from the air filter horn of the carburetor. Air entering through any other method or opening is illegal. An approved spray test method can be used for tech validation.

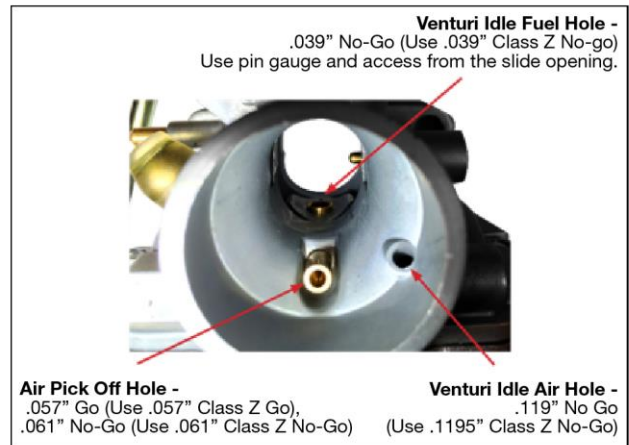
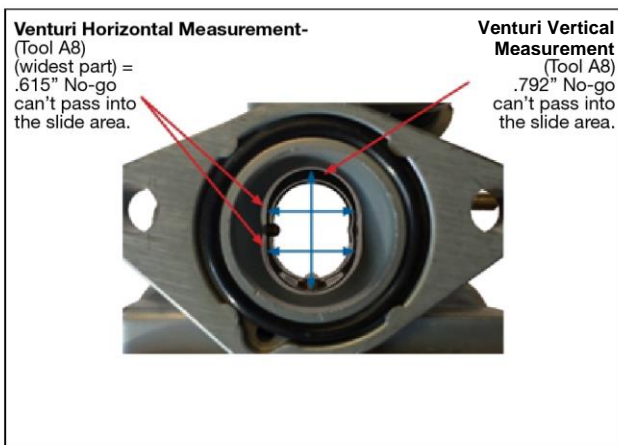
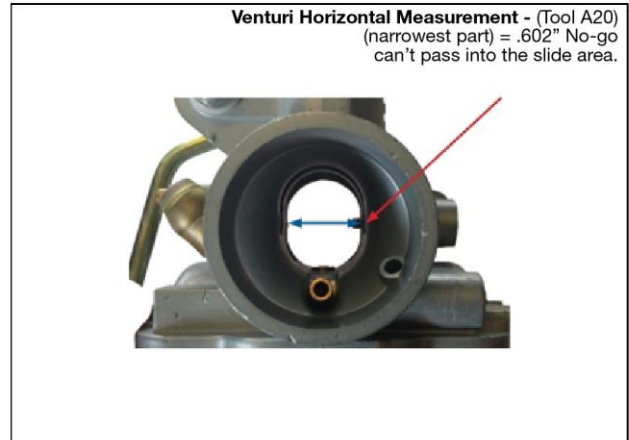
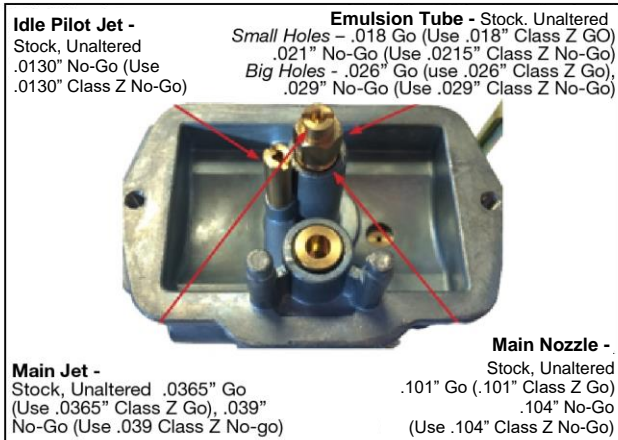

The "Slide Area" is the cylindrical space occupied by the carburetor slide as it moves up and down. Measurement surfaces of Tool A8 and A20 may not enter this space.

Recommended Test Procedure:

1. Set the carb down on its flange or nozzle opening. Ensure the tool (A8 or A20) is being positioned perpendicular to the direction of the carburetor slide travel.
2. Pull the slide out of the venturi opening.
3. Move the tool into the venturi vertically until it makes contact with the inside wall of the carburetor under its own weight.
4. Move the slide in to check for contact with the measurement surface of the tool.
5. If the slide can move to the full extent of its travel without contact with the measurement surface of the tool, the tool is not in the Slide Area.
NOTE: Fastener on A8 is not part of the measurement surface and may enter.
6. Repeat on reverse side of carburetor slide.

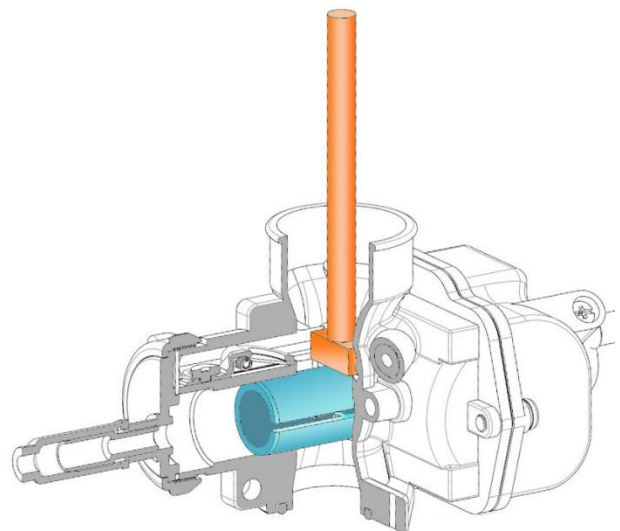

NOTE: Slide openings should be measured only with the Briggs & Stratton slide tool listed on the tool reference chart.

Technical Item	Description	Tech Tool
a. Needle Jet C-Clip	Needle Jet C-clip must be properly installed but may be installed at any of the 5 factory settings on the needle jet.	
b. Throttle Cable Cap	Throttle cable cap on the top of the carburetor must be used and properly installed in tight position.	
c. Choke	Choke: OEM unaltered, but lever may be fastened open with a spring, rubber band, wire, etc.	
d. Idle Pilot Jet	Idle Pilot Jet – Stock, Unaltered .0130" No-Go (Use .0130" Class Z No-Go)	
e. Idle Circuit Air Hole	No drilling, reaming, elongating of the hole allowed. .119" max. diameter. A small chamfer at the outer edge, as compared to a stock part, can be present. The measurement of that chamfer is subject to sanctioning body guidelines.	.1195" Pin gauge
f. Main Jet	Main jet – Stock, Unaltered .0365" Go (Use .0365" Class Z Go), .039" No-Go (Use .039 Class Z No-go)	
g. Emulsion Tube	Main nozzle – OEM stock unaltered hole size = .101, .104" Small holes – .018 Go (Use .018" Class Z GO) .021" No-Go (Use .0215" Class Z No-Go) Big Holes - .026" Go (use .026" Class Z Go), .029" No-Go (Use .029" Class Z No-Go)	
h. Venturi Measurement	Venturi Measurement: Vertical: .792 max inches.	A8
	Horizontal: .615 max inches at widest part	A8
	Horizontal: .602 max inches at narrowest part.	A20
i. Air Pick Off Hole	Air pick off hole - .057 go .061 no go	A9
j. Throttle Bore	Throttle bore – Must be as cast and bore max diameter = .874 inches.	A7
k. Venturi Idle Fuel Hole	Venturi idle fuel hole = .039" No-Go (Use .039" Class Z No-go)	
l. Air Filter	Air filter: Only GREEN air filter, part # 555729 is allowed. Filter adapters are not allowed, filter must attach directly to carburetor air horn	
m. Carburetor Overflow	Carburetor overflow: Must be vented to a catch container.	
n. O-Ring	O-Ring part number B&S part # 555601 is required and must be unaltered.	A12
o. Intake Manifold	Intake manifold – max length = 1.740 inches min to 1.760 inches max	
	Intake manifold – bore diameter = .885 inches min to .905 inches max	A11
p. Choke Bore/Air Horn	1.149 no-go	A7
q. Carb Slide Cutaway	.075 no-go	A10
r. Widest part of Combustion Chamber	2.640	A30

19. Cylinder Head (Updated 1/16/23)

- a. The ONLY head casting for the B&S 206 herein is the 'RT-1', cast into the head just off the head gasket surface (towards the rear of the engine, PTO side). The overall head minimum thickness is 2.431".
- b. Cylinder head must be "as cast". Factory machining marks left on the head gasket surface is NOT a tech item.
- c. Hard carbon may be scraped from head before measuring.
- d. Depth of shallow area of combustion chamber must be .031 inch minimum. This measurement to be taken with a depth gage on both the combustion side and spark plug side of cylinder head.
- e. Depth of the combustion chamber is .342" inches minimum. **Depth measurement is to be taken within the Head Measurement Zone (HMZ) see diagram at right:**
- f. Inspect retainers for alterations that would increase valve spring pressure - .055 to .075 flange thickness. Both valves must have OE stock B&S valve keepers.
- g. Unaltered B&S part #555552 (exhaust) and #555551 (intake) can be checked for appearance, weight, and dimensions. No machining, polishing, easing, or alterations of any kind allowed. Valve surface must remain as factory, with one single 45 degree face. No other additional angles allowed on any part of the valve. **Tech Tool A22.**
- h. Valve Guides: Replacement of valve guides with B&S part #555645 only is allowed. Maximum depth from the head gasket surface to the intake valve guide is 1.255".
- i. Briggs & Stratton heat disperser, p/n 555690 can be installed in the exhaust bolt boss per factory instructions.

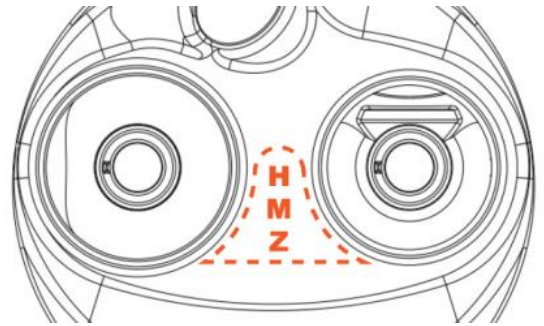

20. Head Gasket

- a. Unaltered Briggs & Stratton part #555723 is the only gasket allowed.
- b. Minimum thickness allowed is .047". Measurement must be performed using a micrometer. Readings are taken from inside the cylinder hole of the gasket closest to the combustion chamber (see diagram). Four measurements are to be taken in the four defined quadrants with three meeting the minimum thickness of .047".



21. Ports

- a. No de-burring, machining, honing, grinding, polishing, sanding, media blasting, etc.
- b. The transition from intake bowl to port must have factory defined machining burr at this junction.

No addition or subtraction of material in any form or matter.

No alterations of any kind may be made to the intake or exhaust ports.

- c. Intake Port: Maximum diameter measurement = .918 inches max. **Tech Tool A6.**
- d. Exhaust Port AS CAST. Exhaust Outlet -.980 – **Tech Tool A6.**
- e. Valve Seats. Intake and exhaust: Must remain factory specification with one 30 and one 45 degree angle only. Valve seats of additional angles and/or angles not comparable to the factory stock are not permitted.
- f. Valve maintenance is permitted. Valve seats must remain with the factory spec of 30 and 45 degree angles only. Valve seats of additional angles and/or excessive material removed when compared to factory stock is prohibited.
- g. Intake valve seat diameter inside = maximum .972 inches. **Tech Tool A2.**
- h. Intake port pocket bowl (area just below valve seat) = .952 no go **Tech Tool A2**
- i. Exhaust valve seat diameter inside = maximum .850 inches. **Tech Tool A1.**

22. Valves

- a. Intake valve

Minimum Weight of Valve	27.8 grams
Diameter of valve stem	.246 to .247 inches
Diameter of valve head	1.055 to 1.065 inches Tech Tool A17
Diameter of valve seat	.972 inches ID maximum
Valve length	Minimum 3.3655 inches
Height from angle of valve face to top of the valve	.057 inches minimum Tech Tool A26

- b. Exhaust valve

Minimum Weight of Valve	27.2 grams
Diameter of valve stem	.246 to .247 inches
Diameter of valve head	.935 to .945 inches Tech Tool A18
Diameter of valve seat	.850 inches ID maximum
Valve length	Minimum 3.3655 inches
Height from angle of valve face to top of the valve	.060 inches minimum Tech Tool A27

23. Valve Springs

- a. Valve Springs are single coil stock, unaltered B&S part #26826. Must be identical in appearance to factory part and have 4.00 to 4.75 coils in stack.
- b. Spring Wire Diameter: .103 to .107 inches
- c. Valve spring length: .940 max inches **Tech Tool A15** Inside diameter: .615" Go (Use .615 Class Z Go), .635" No-Go (Use .635" Class Z No-Go)

24. Rocker Arms, Rocker Ball and Rocker Arm Studs

- a. Rocker arm must be stock B&S serviced part #555711 (US) or #797443 (METRIC) and may not be altered in any way.
- b. Rocker studs must be stock, unaltered B&S service part #694544 US (1/4-28 thread) or #797441 Metric (M8x1.00 thread) and in stock location.
Rocker arm #555711 (US) must be used with rocker stud #694544 (US).
Rocker arm #797443 (Metric) must be used with rocker stud #797441 (Metric).
- c. Rocker Ball must B&S stock. Diameter .590 inch min. to .610 inch maximum. **Tech Tool A16.**
- d. Rocker arm mounting positions may not be altered in any manner. No heli-coiling of mounting holes. No bending of studs.
- e. Rocker arm stud plate must be bolted to the head with one, OEM stock B&S gasket only – no alterations. Maximum thickness of gasket is .060 inches. Rocker plate to head fastener holes must remain stock, .289" max.
- f. Rocker arm – overall length 2.820 inch minimum. Can be checked with a pair of dial calipers.

25. Push Rods

- a. Push rods must be unaltered stock B&S service part #555531.
 - b. Push rod diameter .183 minimum inches to .190 maximum inches.
Push rod length 5.638 minimum inches to 5.658 maximum inches.
Tech Tool A5.
- c. Push rod diameter to be checked 3 points along the length and must pass two planes on each 360 degrees of rotation.

26. Engine Block

- a. Engine block must be unaltered "as cast" B&S factory machined condition. There must be no addition or subtractions of metal or any substance to the inside or outside of the cylinder block.
- b. Both (2) B&S engine seals must be present with both the fastener and seal in "as shipped" from the factory location and condition. Any defined tampering with the fasteners or damage to the wire/seal itself (example: delaminated hologram) are grounds for disqualification.

Take proper care of your seals to ensure their integrity. It is recommended that you wrap your seals (using a plastic bag, etc.) to prevent exposure to harsh solvents such as carb cleaner, etc...

- c. Deck gasket surface finish is not a tech item. Piston pop up can be .0035" maximum. Piston pop-up to be checked with flat bar in center of piston parallel to piston pin and then again checked 90 degrees to piston pin. Push piston down to take up rod play. **Tech Tool A25.**

Angle milling or peak decking is not allowed.

- d. Carbon build-up can be removed before pop-up is measured as long as material is not removed from the piston. Exception – Competitors can deburr the manufacturing part number/marks IF needed as long as:
 - Removal does not extend beyond the defined script area.
 - De-burring does not extend below the original piston surface area.
 - The original part numbers and script are still clearly visible.
- e. Cylinder bore will not be bored oversize
- f. Cylinder bore will not be re-sleeved.
- g. Cylinder bore position is not be moved or angled in any manner.
- h. Cylinder bore dimension: - Briggs & Stratton stock bore is 2.690". Allowance for wear is permitted up to 2.693" maximum for entire length, top to bottom.
- i. Maximum stroke is 2.204". Push piston down to take up rod play. Check stroke on BDC to TDC. **Tech Tool A21.**

27. Valve Lift

- a. Maximum valve lift is checked from the top of the valve spring retainer. Valves must be adjusted to zero clearance.
- b. Valve Lift: Camshaft check is taken at the valve spring retainers. With the lash set at zero, the movement of the valve spring retainers may not exceed the following: Intake and exhaust: .255 inches maximum.

27.5 Rocker Cover Fasteners

- a. The rocker cover fastener closest to the carburetor is non-tech and may be replaced with a sanctioning body provided drilled bolt for the purposes of wire engine sealing mandated by a sanctioning body.

28. Camshaft Profile Limits (measured at push rod) (Updated 1/16/23)

Push gently down on dial indicator stem to ensure that there is no lash when push rods are going down.

NOTE: A single point on each lobe can be off by a maximum of 2 degrees without issue, the exception being on the .006" check, both intake and exhaust.

Intake lift		Exhaust lift	
0.006	59 TO 51 BTDC	0.006	101 TO 93 BBDC
0.020	16 TO 12 BTDC	0.020	59 TO 55 BBDC
0.050	.5 TO 4.5 ATDC	0.050	43 TO 39 BBDC
0.100	17 TO 21 ATDC	0.100	26 TO 22 BBDC
0.150	33.5 TO 37.5	0.150	9 TO 5 BBDC
0.175	43 TO 47 ATDC	0.175	1 TO 5 ABDC
0.200	54 TO 58 ATDC	0.200	11.5 TO 15.5
0.225	68 TO 72 ATDC	0.225	25 TO 29 ABDC
MAX LIFT	0.257	MAX LIFT	0.259
MIN LIFT	0.252	MIN LIFT	0.252

Intake lift		Exhaust lift	
0.225	38 to 34 BBDC	0.225	76 TO 72 BTDC
0.200	24.5 TO 20.5	0.200	62.5 TO 58.5
0.175	14 TO 10 BBDC	0.175	52 TO 48 BTDC
0.150	4.5 TO .5 BBDC	0.150	42 TO 38 BTDC
0.100	12 TO 16 ABDC	0.100	25.5 TO 21.5
0.050	29 TO 33 ABDC	0.050	8.5 TO 4.5 BTDC
0.020	45.5 TO 49.5	0.020	8 TO 12 ATDC
0.006	83 TO 91 ABDC	0.006	47 TO 55 ATDC

Cam Profile Database may be referenced by Tech Officials to confirm Factory dimensions for individual engines.

29. Flywheel

- No modifications are allowed to the flywheel or fan.
- The minimum weight of the flywheel, fins and four bolts is 4 pounds 1 ounce.
- Stock B&S service parts #555683 or #84007232 only. No machining, glass beading, sand blasting, painting or coating of flywheel is allowed.
- A flywheel fan, B&S service part #692592, with broken fins must be replaced.
- Stock, unaltered B&S flywheel key with the B&S logo is required. Width of the key allowed is .1825"-.1875". No offset keyways allowed.

30. Ignition System

- Unaltered B&S stock ignition** part #555718 is mandatory. Only "GREEN" ignition module allowed. Maximum RPM: 6,150.
Exception – Cadet Junior 206 class requires the use of unaltered B&S stock ignition part #555725 (BLACK in color). Maximum RPM: 4,150.
- Coil or its position**, other than air gap, may not be altered in any way. Coil mounting bolts must be stock and cannot be altered in any way to advance or retard timing. Attachment bolts and/or bolt holes may not be altered.

- c. **Spark plug:** Only the AutoLite AR3910X spark plug UNALTERED in any way from the OEM (B&S service part number #84005196) is permitted. Spark plug must have the "AutoLite" and "AR3910X" identification on the insulator.

NOTE: Technical Inspectors may, at their own discretion, at any time, visually inspect and retain a competitors spark plug and replace it with a new AutoLite AR3910X spark plug.

Sealing washer must be in place, unmodified from the factory.

Temperature thermocouple is permitted as long as sealing washer and/or cylinder heat shield with spark plug hole are not modified.

- d. Spark plug connector: Only the OEM B&S part #555714 is permitted.
- e. Magneto air gap is non-tech (recommended clearance of .016")
- f. Static check for timing:
- Install a degree wheel using a positive stop method.
 - With the left edge of the first magnet aligned with the start of the lead leg of the ignition (refer to photo), the engine must not exceed 26 degrees with air gap set at .016". Timing checked in the direction the engine operates.

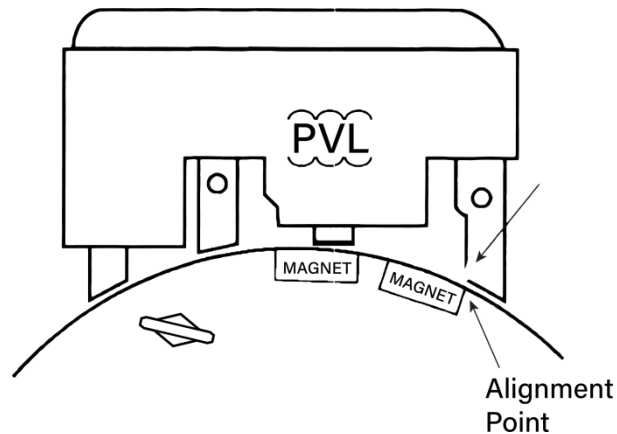

31. Crankcase

Crankcase and cover must be Briggs & Stratton stock, unaltered, "as cast in factory" condition. No alterations or subtractions of metal or any other substance to crankcase cover.

32. Clutch

- a. Novice class must run the supplied Max-Torque clutch, part #555727. No alteration to the clutch is allowed. Springs, driver (when applicable) and clutch key are non-tech.

- b. Sportsman, Junior 1, Junior 2, Senior, and Masters Classes must run one of the following clutches:
 - 1. Inferno Racing by Hilliard: Fire, Flame, Blaze or Fury
 - 2. Max-Torque: Draggin Skin or SS
 - 3. Noram/Premier: Magnum, GE, Ultimate or Stinger*
 - * NOTE: Noram/Premier Stinger must be converted to stamped drum (Noram P/N 01600715) to be legal for competition.
- c. Sprocket conversion drums/kits manufactured by Inferno by Hilliard, Max-Torque or Noram may be used. Sprocket conversion drums/kits from other manufacturers are prohibited.
- d. Refer to Page 21-25 for diagrams/photos of approved clutches
- e. Clutch or sprocket conversion drum/kit must be used as shipped from the original manufacturer – Inferno by Hilliard, Max-Torque or Noram. Mixing of parts between clutch lines, manufacturers or removing parts (i.e.; grease guard, etc.) is prohibited. No alteration or machining to the clutch allowed except light sanding to shoe and drum mating surface for maintenance.
- f. Interchangeable drivers (i.e.; 15T, 16T, etc) and driver configuration (#35 or 219), driver clip/lock, clutch key, and crankshaft fastener kit are non-tech. OEM springs and weights MUST remain unmodified, OEM but are a racer’s choice. Clutch coolers are not allowed. The use of aftermarket coatings is prohibited.
- g. Clutch Claim Rule: Per standard sanctioning body guidelines, claiming can be implemented, maximum of \$160.00.
- h. Manufacturers who wish to be considered for future rule sets may submit requests to: briggsracing@basco.com

33. Starter

Recoil starter, B&S service part #695287, must be retained, as produced and intact. Starter maybe rotated.

34. Exhaust Header

- a. Header must be RLV #EXF5520 (formerly 5506), EXF5507, or EXF5511 for all non-Kid Kart classes.
 - NOTE: RLV EXF5520 may not be allowed in the 2024 Briggs 206 Rule Set.
- b. Header length:
 - EXF5507 and EXF5511 will measure 18.75" +/- .25" along the short side using a 0.250" wide tape measure.
 - EXF5520 (formerly 5506) will measure 17.50" +/- .25" along the short side using a 0.250" wide tape measure.
- c. Gasket and/or silicone are allowed to seal header to head (One gasket max)
- d. Studs or bolts are permitted to fasten header to head.
- e. Bolts or nuts must be safety wired to prohibit threads from backing out.
- f. If header bolts loosen during a race but the header remains attached to the head with two bolts/nuts, this is not grounds for disqualification.

- g. Helicoiling of the exhaust is allowed.
- h. Supplied header support brace is mandatory. The addition of a mechanical support bracket (no welding involved) is allowed provided that there are no alterations to the shape or dimensions of the exhaust configuration.
- i. Any modification for or use of an O2, EGT, CO2 sensor is prohibited.

35. Exhaust Silencer

Silencer must be RLV B91XL (part number 4104) with round baffle holes only. Safety wiring of the silencer to header is mandatory. All 4 baffles must remain unaltered and the hole size can be verified using a no-go pin of .1285. Exhaust gases may only exit through the muffler baffles. Muffler must be mounted on the header in a way that does not allow exhaust to leak at this joint.



36. Exhaust Protection

The header must be completely wrapped (360 degrees) with a non-asbestos, approved insulation material or sleeve starting approx. 3 inches from the exhaust flange but MUST extend to where the stock supplied RVL support (welded or clamped) meets the header.

37. Technical Inspection Tools

Videos of tools and processes are available at www.BriggsRacing.com.

38. Important Online Support Resources











Please refer to www.BriggsRacing.com for a host of resources. Due to the sealed nature of this engine we highly recommend reading and viewing important documents and videos to insure a great racing experience.

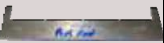











- a. 206 Engine tips and guide supplement – A must to print out and read BEFORE installing your engine!
- b. Carburetor tuning guide – Understand your carburetor to get the most out of your 206.
- c. Videos:
 - Proper clutch installation: Properly installing your clutch will prevent the possibility of crankshaft damage.
 - Setting the float height: A simple video highlighting a necessary technique to insure a properly tuned carburetor.
 - Setting, measuring, and optimizing your junior slide restrictor.

**UNLESS THESE RULES STATE THAT YOU
CAN DO IT, YOU CANNOT DO IT.**

**EACH RACER IS SOLELY RESPONSIBLE TO MAINTAIN AND
CHECK ENGINE LEGALITY PER THIS PUBLISHED RULE SET**

TOOL REFERENCE

	Exhaust Valve Seat Diameter Max: 0.850 Tool: A1
	Intake Valve Seat Diameter Max: 0.972 Tool: A2 Intake Port Pocket Bowl Gauge Max: 0.952
	Needle Jet Diameter Max: 0.070 Tool: A4
	Push Rods Length Max: 5.658 Min: 5.638 Tool: A5
	Intake Inlet Diameter Max: 0.918 Tool: A6
	Exhaust Outlet Diameter Max: 0.980 Tool: A6
	Throttle Bore Diameter Max: 0.874 Tool: A7
	Choke Bore Diameter Max: 1.149 Tool: A7
	Venturi Measurement Vertical Max: 0.792 Tool: A8 Horizontal Max: 0.615
	Air Pick Off Hole Tool: A9 Diameter .057" Go (Use .057" Class Z Go) .061" No-Go (Use .061" Class Z No-Go)
	Slide Cutaway Tool: A10 Max: .075 No go
	Intake Manifold Tool: A11 Diameter Max: 0.905 Min: 0.885
	Intake Manifold Tool: A12 Length Max: 1.760 Min: 1.740
	Rocker Arm Tool: A13 Length Min: 2.820

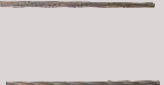
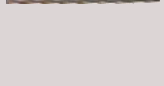
	Valve Spring Tool: A15 Length Max: 0.930												
	Rocker Ball Tool: A16 Length Max: 0.610 Min: 0.590												
	Intake Valve Head Tool: A17 Diameter Max: 1.065 Min: 1.055												
	Exhaust Valve Head Tool: A18 Diameter Max: 0.935 Min: 0.945												
	Venturi Measurement Tool: A20 Horizontal Min: 0.602												
	Stroke Tool: A21 Length Max: 2.204												
	Valve Angle Tool: A22 Angle Max: 45° Min: 45°												
	Piston Pop Out Tool: A25 Length Max: .0035												
	Intake Valve - Height from angle of valve face to top of the valve Length Min: 0.057 Tool: A26												
	Exhaust Valve - Height from angle of valve face to top of the valve Length Min: 0.060 Tool: A27												
	Width of Widest Part of Combustion Chamber Tool: A30 Length Max: 2.640												
	Slide Tool ASN Canada FIA National Class Structure <table border="1" style="font-size: small;"> <thead> <tr> <th>Class</th> <th>Max. Slide Opening</th> </tr> </thead> <tbody> <tr> <td>Junior</td> <td>.570" 'Yellow'</td> </tr> </tbody> </table> Briggs & Stratton 206 Club Class Options <table border="1" style="font-size: small;"> <thead> <tr> <th>Class</th> <th>Max. Slide Opening</th> </tr> </thead> <tbody> <tr> <td>Cadet</td> <td>.310" 'Black'</td> </tr> <tr> <td>Novice</td> <td>.342" 'Purple'</td> </tr> <tr> <td>Junior I</td> <td>.490" 'Green'</td> </tr> </tbody> </table>	Class	Max. Slide Opening	Junior	.570" 'Yellow'	Class	Max. Slide Opening	Cadet	.310" 'Black'	Novice	.342" 'Purple'	Junior I	.490" 'Green'
Class	Max. Slide Opening												
Junior	.570" 'Yellow'												
Class	Max. Slide Opening												
Cadet	.310" 'Black'												
Novice	.342" 'Purple'												
Junior I	.490" 'Green'												
	Jetting Idle Pilot Jet – Stock, Unaltered .0130" No-Go (Use .0130" Class Z No-Go) Main Jet – Stock, Unaltered .0365" Go (Use .0365" Class Z Go), .039" No-Go (Use .039 Class Z No-go)												
	Emulsion Tube Main nozzle – OEM stock unaltered hole size = .101, .104" Emulsion Tube - Small holes – .018 Go (Use .018" Class Z GO) .021" No-Go (Use .0215" Class Z No-Go) Big Holes - .026" Go (use .026" Class Z Go), .029" No-Go (Use .029" Class Z No-Go)												

APPROVED CLUTCH GUIDE

Inferno by Hilliard Fire

FRONT



BACK



Inferno by Hilliard Flame

FRONT



If Bronze Bushing is used,
Grease Trap may be omitted

BACK



Inferno by Hilliard Blaze

FRONT



If Bronze Bushing is used,
Grease Trap may be omitted

BACK



APPROVED CLUTCH GUIDE

Inferno by Hilliard Fury

FRONT



If Bronze Bushing is used,
Grease Trap may be omitted

BACK



Max-Torque Draggin Skin

FRONT



BACK



Max-Torque SS

FRONT



BACK



APPROVED CLUTCH GUIDE

Premier Magnum Heavy

FRONT



BACK



Premier Magnum Light

FRONT



BACK



Noram GE Heavy

FRONT



BACK



APPROVED CLUTCH GUIDE

Noram GE Light

FRONT



BACK



Noram GE Ultimate Heavy

FRONT



BACK



Noram GE Ultimate Light

FRONT



BACK



APPROVED CLUTCH GUIDE

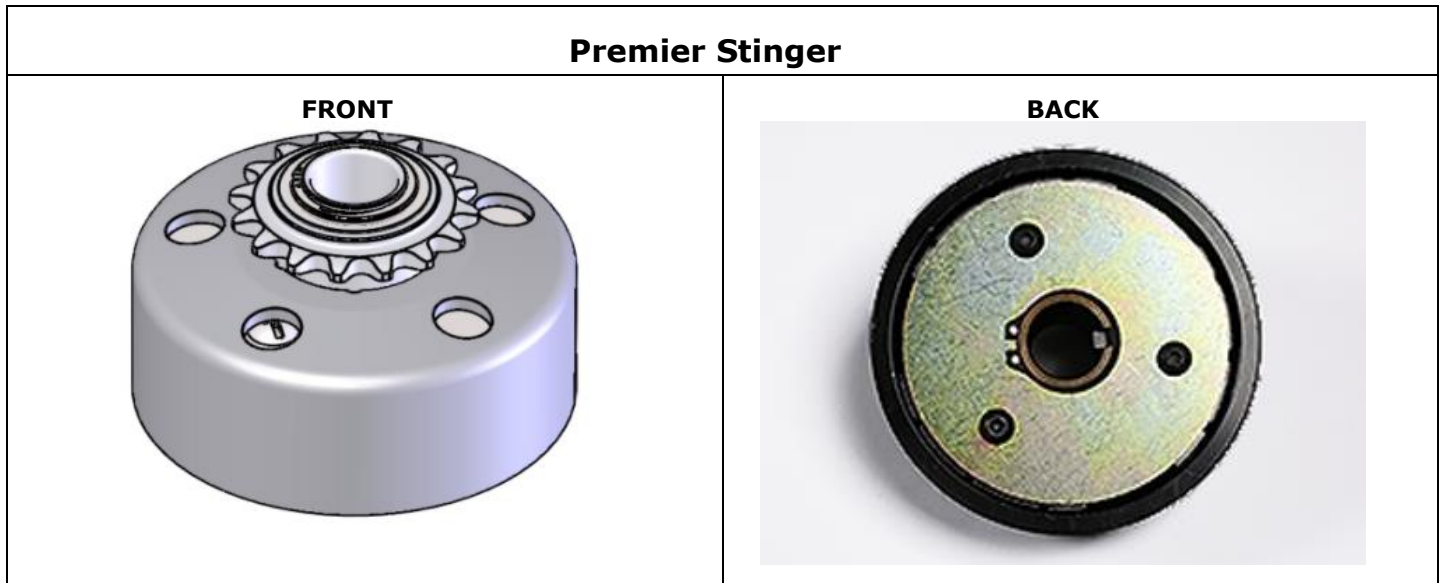

Manufacturers who wish to be considered for future rule sets may submit requests to: briggsracing@basco.com

TORQUE SETTING GUIDELINES

Description	Tool Size	Torque
Air Guard	7mm	40-50 lb-in. (4.5-5.6 Nm)
Blower Housing	10mm	60-110 lb-in. (7-12.5 Nm)
Rewind Starter	10mm	25-35 lb-in. (2.8-4 Nm)
Carburetor (to manifold)	10mm	80-110 lb-in. (9-12.4 Nm)
Cylinder Head Bolts	10mm	200-220 lb-in. (20-27 Nm)
Exhaust Brace Screws	10mm	95-125 lb-in. (11-14 Nm)
Flywheel Nut	15/16	105-115 ft-lbs. (142.4-156 Nm)
Flywheel Fan	10mm	180-240 lb-in. (20-27 Nm)
Intake (to Head)	5mm Allen	70-90 lb-in. (8-10.2 Nm)
Oil Drain Plug	10mm Star Socket	100-125 lb-in. (11-14 Nm)
Ignition Module	7mm	20-35 lb-in. (2.3-4 Nm)
Rocker Arm Stud	10mm	90-120 lb-in. (10-14 Nm)
Rocker Arm Plate	10mm	70-90 lb-in. (7.9-10.1 Nm)
Rocker Arm Set Screw	4mm Allen	50-70 lb-in. (5.6-7.9 Nm)
Spark Plug	5/8" Deep	140-200 lb-in. (15.8-22.6 Nm)
Top Control Plate	10mm	70-90 lb-in. (8-10 Nm)
Center Fuel Pump Bolt	10mm	50-60 lb-in. (5.6-6.8 Nm)
Valve Cover	10mm	30-60 lb-in. (3.5-7 Nm)